

Features

- 33" (838 mm) minimum base cabinet width.
- Double-equal bowls.
- 9" (229 mm) depth provides generous workspace.
- Four faucet holes.
- Rear drain increases workspace in the sink and storage space underneath.
- Includes cutout template.

Material

- KOHLER® enameled cast iron.

Installation

- Top-mount.

Recommended Products/Accessories

- K-6121 Left-Bowl Sink Rack
- K-6122 Right-Bowl Sink Rack
- K-8801 Sink Strainer
- K-8799 Sink Strainer
- K-23726 Drain treatment
- K-23725 Cast iron cleaner

Optional Products/Accessories

- K-6545 Sponge Caddy
- K-11352 Disposal Flange with Stopper
- K-9000 P-Trap



Codes/Standards







ASME A112.19.1/CSA B45.2

KOHLER® Enameled Cast Iron Kitchen Sink Lifetime Limited Warranty

See website for detailed warranty information.

Available Colors/Finishes

Color tiles intended for reference only.

Color	Code	Description
	0	White
	FF	Sea Salt™
	96	Biscuit
	47	Almond
	FD	Cane Sugar™
	95	Ice™ Grey
	7	Black Black™

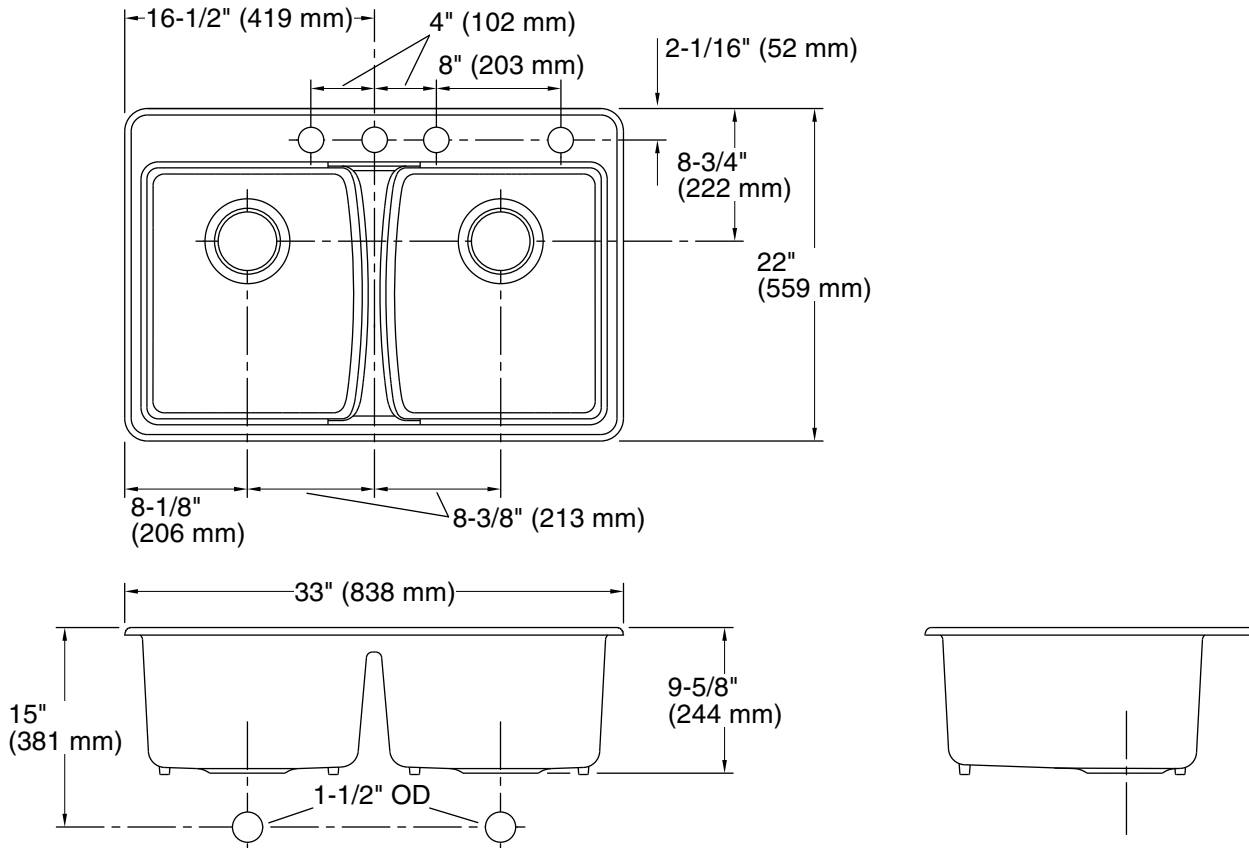

Technical Information

All product dimensions are nominal.

Bowl configuration: Double equal

Installation: Top-mount

Min. base cabinet width: 33" (838 mm)

Bowl area (Left): Length: 14-1/4" (362 mm)
Width: 16-9/16" (421 mm)
Bowl depth: 9" (229 mm)

Bowl area (Right): Length: 14-1/4" (362 mm)
Width: 16-9/16" (421 mm)
Bowl depth: 9" (229 mm)

Number of deck holes: 4

Faucet hole spacing: 4" (102 mm)

Faucet hole(s): 1-3/8" (35 mm)

Drain hole: 3-7/8" (98 mm)

Template: 1171757-7, required, included

Notes

Install this product according to the installation instructions.

NOTICE: Countertop manufacturer or cutter must use the cutout template provided with the product, or a current one provided by Kohler Co. (call 1-800-4-KOHLER). Kohler Co. is not responsible for cutout errors when the incorrect cutout template is used.